

2-82
gla

1

Dr. 1946-

RFP-3032/1
UC-60

30

I-1705

MCDONNELL 40-KW GIROMILL WIND SYSTEM

MASTER

NOTICE

THIS REPORT IS ILLEGIBLE TO A DEGREE
THAT PRECLUDES SATISFACTORY REPRODUCTION

Phase I-Design and Analysis Volume I-Executive Summary

DO NOT MICROFILM COVER

August 1979

**J.W. Anderson
R.V. Brulle
E.B. Birchfield
W.D. Duwe**

Prepared by
MCDONNELL AIRCRAFT COMPANY
P.O. Box 516
St. Louis, Missouri 63166

For
Rockwell International Corporation
Energy Systems Group
Rocky Flats Plant
Wind Systems Program
P.O. Box 464
Golden, Colorado 80402

Subcontract No. PF-64100

As Part of the
U.S. DEPARTMENT OF ENERGY
WIND ENERGY TECHNOLOGY DIVISION
FEDERAL WIND ENERGY PROGRAM

Contract No. DE-AC04-76DP03533

DISTRIBUTION OF THIS DOCUMENT IS UNLIMITED

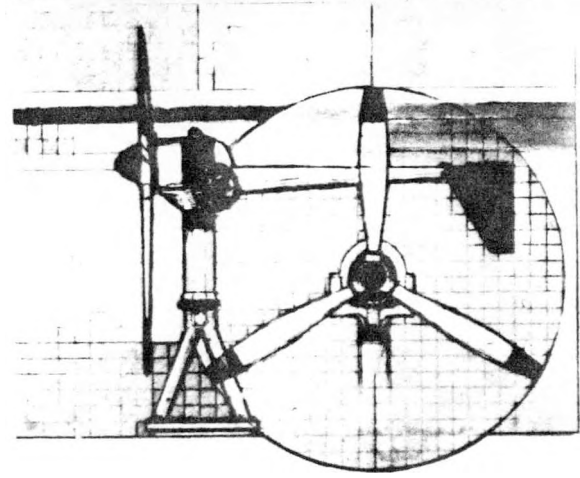
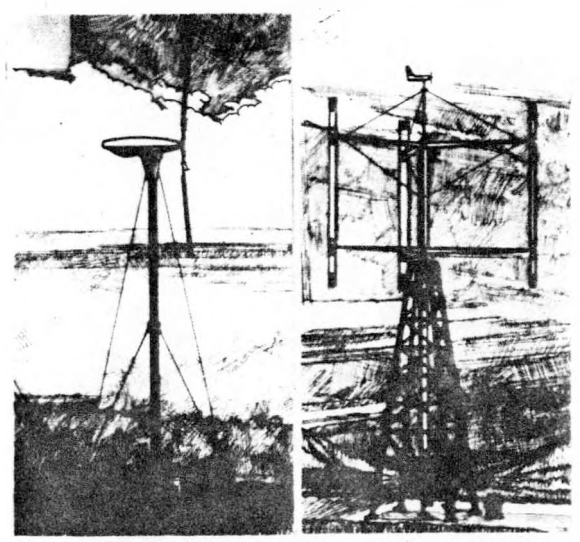

DISCLAIMER

This report was prepared as an account of work sponsored by the United States Government. Neither the United States nor the United States Department of Energy, nor any of their employees, makes any warranty, express or implied, or assumes any legal liability or responsibility for the accuracy, completeness, or usefulness of any information, apparatus, product, or process disclosed, or represents that its use would not infringe privately owned rights. Reference herein to any specific commercial product, process, or service by trade name, mark, manufacturer, or otherwise, does not necessarily constitute or imply its endorsement, recommendation, or favoring by the United States Government or any agency thereof. **The views** and opinions of authors expressed herein do not necessarily state or reflect those of the United States Government or any agency thereof.

Printed in the United States of America

Available from

National Technical Information Service
U.S. Department of Commerce
5285 Port Royal Road
Springfield, VA 22161

Printed Copy \$5.00 Microfiche \$3.50

DISCLAIMER

This report was prepared as an account of work sponsored by an agency of the United States Government. Neither the United States Government nor any agency thereof, nor any of their employees, makes any warranty, express or implied, or assumes any legal liability or responsibility for the accuracy, completeness, or usefulness of any information, apparatus, product, or process disclosed, or represents that its use would not infringe privately owned rights. Reference herein to any specific commercial product, process, or service by trade name, trademark, manufacturer, or otherwise does not necessarily constitute or imply its endorsement, recommendation, or favoring by the United States Government or any agency thereof. The views and opinions of authors expressed herein do not necessarily state or reflect those of the United States Government or any agency thereof.

DISCLAIMER

Portions of this document may be illegible in electronic image products. Images are produced from the best available original document.

RFP--3032/1

RFP-3032/1
UC-60

DE82 011535

MCDONNELL 40 KW
GIROMILL
WIND SYSTEM

Phase I - Design and Analysis

Volume I - Executive Summary

August 1979

J.W. Anderson
R.V. Brulle
E.B. Birchfield
W.D. Duwe

Prepared by

✓
(McDonnell Aircraft Company
P.O. Box 516
St. Louis, Missouri 63166

For

Rockwell International Corporation
Energy Systems Group
Rocky Flats Plant
Wind Systems Program
P.O. Box 464
Golden, Colorado 80402

Subcontract No. PF-64100

As Part of the

U.S. DEPARTMENT OF ENERGY
WIND ENERGY TECHNOLOGY DIVISION
FEDERAL WIND ENERGY PROGRAM

Contract No. DE-AC04-76DP03533

DISCLAIMER

This book was prepared as an account of work sponsored by an agency of the United States Government. Neither the United States Government nor any agency thereof, nor any of their employees, makes any warranty, express or implied, or assumes any legal liability or responsibility for the accuracy, completeness, or usefulness of any information, apparatus, product, or process disclosed, or represents that its use would not infringe privately owned rights. Reference herein to any specific commercial product, process, or service by trade name, trademark, manufacturer, or otherwise, does not necessarily constitute or imply its endorsement, recommendation, or favoring by the United States Government or any agency thereof. The views and opinions of authors expressed herein do not necessarily state or reflect those of the United States Government or any agency thereof.

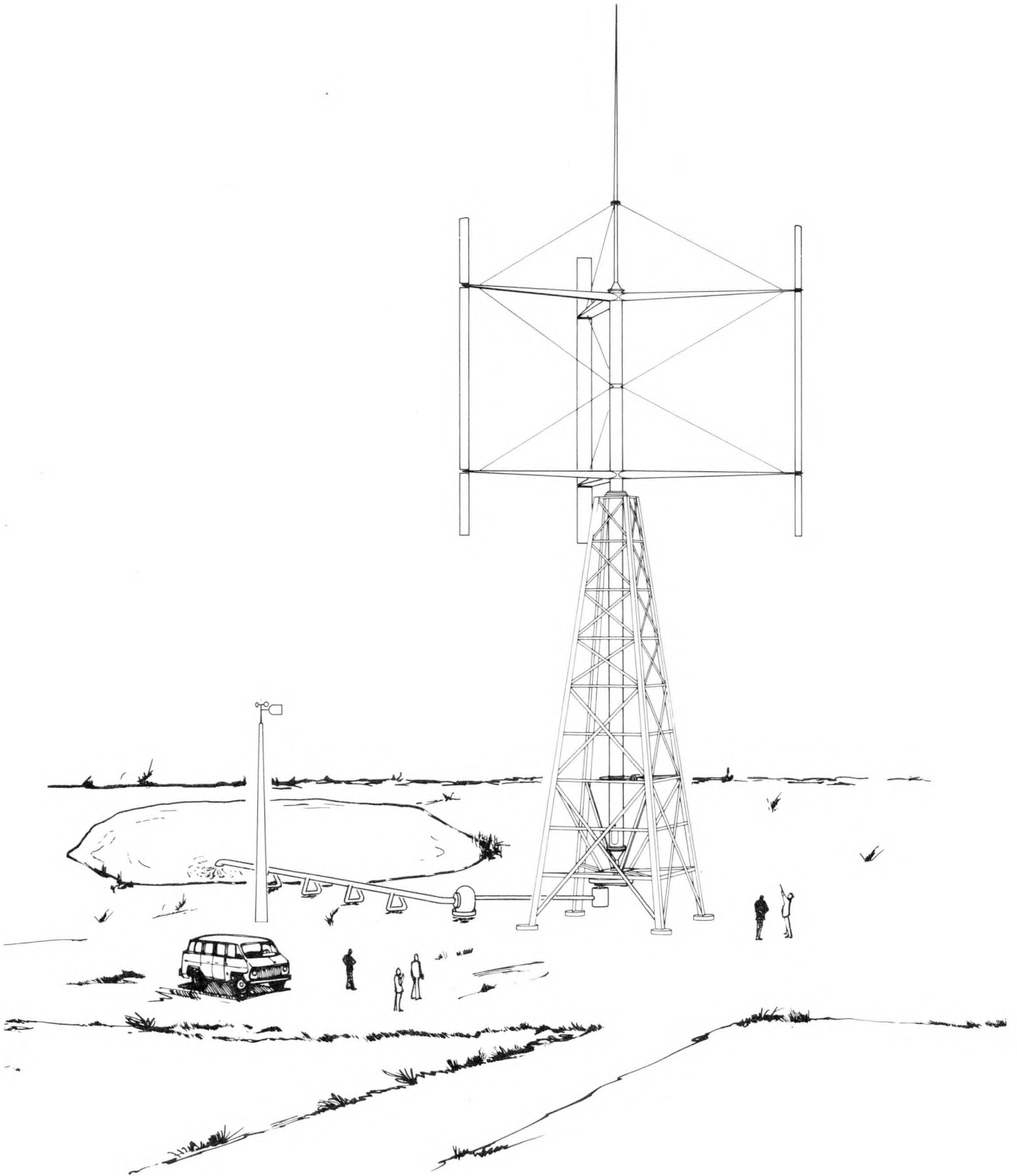

FRONTISPIECE

FOREWORD

This report summarizes the results of Phase I of a program to design and test a 40 kW vertical axis windmill called a "Giomill". Phase I of this program covered trade studies, choice of a preferred configuration and detail design of that configuration. The 9-month program was conducted under contract PF64100F, awarded by the Rockwell International Energy Systems Group at Rocky Flats, Colorado, as part of the Department of Energy's (DOE) small windmill development program. Mr. Eugene Bange of Rockwell International was Contract Monitor.

McDonnell Aircraft Company (MCAIR) was prime contractor, with major assistance from Valley Industries through a subcontract and license agreement and from McDonnell Douglas Electronics Division (MDEC) through an intercompany work order. Valley Industries designed the fixed tower, the rotating tower, the support arms, and the mechanical and electrical output systems. Valley also designed the foundation. MDEC designed the control system and the blade actuators.

Mr. J. W. Anderson was Program Manager for MCAIR, Mr. William Duwe was Engineering Manager for Valley Industries, and Mr. Bert Lindsey was Engineering Manager for MDEC. The principal engineers for MCAIR were Messrs. Burt Birchfield, Bob Brulle, and Warren Strutman; for Valley Industries, Mr. Jim Herr; and for MDEC, Messrs. Tom Schmidt, Bob Udell, and Dick Grau.

This report is in two volumes. Volume I is an executive summary; Volume II contains a technical discussion of the entire program.

TABLE OF CONTENTS

<u>Section</u>	<u>Page</u>
1. INTRODUCTION	1
BACKGROUND	1
PROGRAM DESCRIPTION	1
2. DESIGN TRADE STUDIES	1
3. DESIGN CRITERIA.	2
4. AERODYNAMICS AND PERFORMANCE	2
5. EXTERNAL LOADS	3
6. ROTOR DESIGN	4
7. FIXED TOWER.	5
8. WEIGHTS.	6
9. STRUCTURAL DYNAMICS.	6
10. CONTROL SYSTEM DESIGN.	6
11. MECHANICAL AND ELECTRICAL OUTPUT POWER SYSTEM	10
12. FAILURE MODE AND EFFECTS ANALYSIS.	10
13. TEST INSTRUMENTATION	10
14. TEST PLAN.	11
15. PRELIMINARY BUDGETARY PRODUCTION COSTS	11
16. CONCLUSIONS AND RECOMMENDATIONS.	11
17. REFERENCES	11

LIST OF ILLUSTRATIONS

<u>Figure No.</u>	<u>Page</u>
1 Selected Configuration.	1
2 40 Kw Wind Conversion System Specifications	2
3 Blade Aerodynamic Characteristics.	2
4 Giromill Blade Aerodynamic Characteristics.	2
5 Giromill Control Performance.	3
6 Power Output Breakdown.	3
7 Annual Energy	3
8 Annual Energy (Rotor Centerline at h = 50 ft)	3
9 Summary of Critical Design Load Conditions.	3
10 Giromill Ultimate Design Load (Condition 1)	4
11 Blade Aerodynamic Normal Load	4
12 Blade Cross-Section	4
13 Blade General Arrangement	4
14 General Arrangement Support Arm	5
15 Arm/Tower Attachment.	5
16 Rotating Tower.	5
17 Fixed Tower	5
18 Upper Bearing Mounting (Side View).	5
19 Foundation Pier	6
20 Giromill Weight Breakdown	6
21 Structure Frequencies vs Rotation (Fixed Coordinate System)	6
22 Steady State Linearized Control System Representation	7
23 Steady State Linearized Control Time Responses.	7
24 Blade Loads Due to Severe Gust.	7
25 Below Rated Power Wind Gust	8
26 Above Rated Power Wind Gust	8
27 Blade 1 Rock Angle and Rock Angle Error (Below Rated Wind Gust)	8
28 Blade 1 Rock Angle and Rock Angle Error (Above Rated Wind Gust)	8
29 Wind Gust Runs Comparison	8
30 Blade Actuator Requirements (40 MPH).	8
31 Blade Actuator Maximum Rate and Acceleration.	8
32 Actuator Model Comparison (40 MPH).	9
33 Programmed Rock Angle Profiles.	9
34 Giromill Control System - Processor Phase Sequence.	9
35 Blade Actuator Assembly	9
36 Electrical Drive System Assembly.	10
37 Block Diagram of Giromill Electrical Output Power for Operation with a Large Utility Grid .	10
38 Partial Instrumentation Approach.	10
39 Ground Rules for Costing 1000th Unit.	11
40 Giromill Budgetary Cost Estimate.	11

ABSTRACT

The objective of Phase I of this contract was to determine a preferred configuration for the 40kW Giromill and to design that configuration. Phase I began on September 15, 1978 and was completed on June 15, 1979. Phase II, fabrication and testing, began on May 15, 1979, and results will be covered later.

The Giromill is a vertical axis windmill with a series of articulated vertical blades whose angles are controlled to maintain a constant RPM (when wind speed is sufficient). A microprocessor is used to process information on wind speed, wind direction, and RPM and establish blade position.

The prototype Giromill, when connected to a utility grid, is designed to supply 40kW in a 20 MPH wind. By means of a kit, it can be converted to a stand-alone machine having a mechanical output. A 30-year life was a design objective. The Giromill is designed to withstand a peak gust of 125 MPH with a 1.5 safety factor.

Phase I was nine months. It consisted first of a four-month period of trade studies during which a number of variations in the design were studied. Out of these studies evolved the configuration which became the basis for a six-month design period, which began during the last month of the trade-off period. Additional tasks performed during design were a Failure Mode and Effect Analysis, Preparation of a Test Plan, Definition of Test Instrumentation, and a Preliminary Production System Cost Analysis.

1.0 INTRODUCTION

The objective of Phase I of the program was to determine the best configuration for a 40 kW output vertical axis windmill and to complete its detail design.

BACKGROUND - Little effort has been spent toward development of vertical axis windmills with modulating blades. However, several studies and tests, including two performed by MCAIR for ERDA References 1 and 2, have indicated that this type vertical axis Giromill has a higher wind energy conversion efficiency than other windmills. For the same power output, a smaller projected area is required for the Giromill.

The solidity chosen for the Giromill, however, is higher than that for a typical horizontal machine of the same power; and that, plus the requirement for blade support arms, results in more rotating structure. On the other hand the blades and support arms can be manufactured at lower cost than the more complex blades of some horizontal axis machines.

Each machine has complexities. The horizontal axis machine requires a yaw control system to keep its relatively heavy horizontal shaft and generator assembly turned into the wind. This also complicates the transfer of shaft power to ground level. For a modulating blade vertical axis machine the rapid and continuous positioning of the blades may result in higher maintenance and replacement costs.

PROGRAM DESCRIPTION - Phase I of this program began during the first four months with design trade studies and development of design criteria. Near the end of these tasks, when the major elements of the selected configuration had been determined, detailed design began.

MCAIR designed the blades, which will be fabricated by MCAIR at St. Louis.

The other parts of the rotor, the support arms, and rotating tower were designed by Valley personnel. These parts will be fabricated at the Tallulah, La., plant of Valley Industries. Valley also designed the fixed tower and will fabricate it at Tallulah.

The foundation is similar to designs used frequently by Valley for fire lookout or windmill towers.

The control system was the primary responsibility of MDEC. The MDEC division in St. Charles, Mo., designed the control unit and will build it. The MDEC division in Grand Rapids, Michigan, designed the actuator package, consisting of an electric motor, gear box, and amplifying unit. The basic electric motor will be procured from a vendor, but special windings will be installed by MDEC. MDEC designed the gear box and the amplifier and will build it in Grand Rapids.

The mechanical and electrical output systems were designed by Valley. Many of the components will be procured from vendors; the remaining parts will be fabricated at Tallulah.

2. DESIGN TRADE STUDIES

Seven major trade studies were conducted to arrive at the best design for the prototype unit. There were:

- 1) Geometry - Varied the blade and support arm arrangements, rotor aspect ratio, number of blades, and blade thickness.
- 2) Drive System - Looked at planetary versus parallel shaft helical gear speed increasers, and induction versus synchronous type generators.
- 3) Control System - Compared a hydro/mechanical with a microprocessor type controller, and looked at hydraulic and electrical blade actuators.
- 4) Blade - Looked at different blade support locations. Investigated a blade offset hinge concept and blade structural arrangement. Also compared a steel versus aluminum concept.
- 5) Blade Support Arms Design - Three concepts were compared: (1) a tube/welded sheet metal, (2) bolted truss, and (3) a formed and welded box.
- 6) Rotating Tower - Diameter and thickness variations were considered. Also the pros and cons of extending the tower to ground level were considered.
- 7) Fixed Tower - A study of a cylindrical steel tower versus a truss type tower was made.

The results of all these trade studies led to the selection of the preferred design shown in Figure 1. It has three blades 42 ft long. They have a NACA-0018 airfoil. Support arms are arranged to give minimum blade bending moment. The rotor diameter is 58 ft, giving a rotor aspect ratio of 0.72.

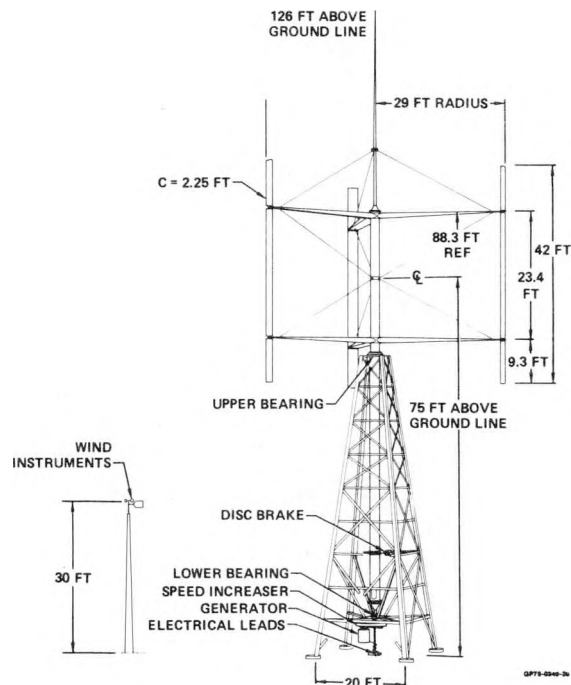

FIGURE 1 SELECTED CONFIGURATION

A parallel shaft helical gear speed increaser, is used with a toothed belt drive to an induction generator.

An electronic control system that gives complete stand-alone capability is used. Electric actuators modulate the blades.

Three piece aluminum blades are used which have the pivot point at 22% chord. They are supported by streamlined formed welded support arms braced by streamlined struts. The rotating tower has a 24 in. diameter and extends to ground level. This places most of working parts near the ground for easy maintenance.

A truss tower is used. Two bearings support the rotating tower, which is topped by a lightning pole. The wind instruments are located on a separate pole.

3.0 DESIGN CRITERIA

Design requirements for the Giromill were defined. The major ones are shown in Figure 2. A design objective was to have a system life of 30 years, which relates to about 72,000 operating hours at full power. Also a cost goal of \$500/kW was specified for the final production system (1000th unit).

Four electrical system designs are required, although only Design 1, which ties in with an electrical utility grid, is to be manufactured. A kit that converts the electrical system to a mechanical drive system having an output RPM of 1760 is to be constructed. Kit installation should be accomplished with a minimum of modification.

	ELECTRICAL	MECHANICAL
OUTPUT POWER MODE OPTIONS	40 kW MIN. IN 9 m/s (20 MPH) AT SEA LEVEL DENSITY. 60 Hz. POWER FACTOR OF 0.8 OR HIGHER 1. MATCH WITH EXISTING UTILITY GRID: 3-PHASE, 480 VOLT ±5% 2. INDEPENDENT OF UTILITY GRID: SINGLE MACHINE, 3-PHASE, 480 VOLT ±5% 3. INDEPENDENT OF UTILITY GRID: SINGLE MACHINE, 240 VOLT ±5% 4. 3-PHASE 480 VOLT ±5%, FOR TIE-IN OF TWO OR MORE MACHINES	40kW MINIMUM IN 9 m/s WIND HORIZONTAL SHAFT AT CONSTANT SPEED OF EITHER 440, 880, OR 1760 RPM. SHAFT SPEED NOT TO VARY MORE THAN ±1% FOR WIND SPEED GREATER THAN 9 m/s
HEIGHT	CENTERLINE OF ROTOR SWEEP AREA TO BE AT A HEIGHT OF 75 FT.	SAME
WIND RANGE		
CUT-IN	MINIMIZE WITH REGARDS TO ECONOMICS OF POWER PRODUCTION AND SYSTEM COST	SAME
CUT-OUT*	27 m/s (60 MPH) MINIMUM. SELECTION OF A LOWER SPEED TO BETTER MEET PROGRAM OBJECTIVE OF LOW-COST POWER PRODUCTION MUST BE ADEQUATELY JUSTIFIED.	SAME
PEAK GUST PROTECTION	56 m/s (125 MPH) MINIMUM WITH A 1.5 SAFETY FACTOR	
CONTROLS		
START/STOP SHUTDOWN/CONTROL	AUTOMATIC AUTOMATIC FOR ROTOR OVERSPEED BACK-UP SHUTDOWN MECHANISM.	SAME
OPERATION	AUTOMATIC CUT-IN, AND CUT-OUT AUTOMATIC RE-ENGAGE AS WINDS DROP BELOW CUT-OUT SPEED	
OUTPUT	AS REQUIRED TO PROVIDE PROPER OUTPUT POWER MODE	

*A cut-out wind speed of 40 mph was selected for the prototype.

GP79-0826-133

FIGURE 2 40 kW WIND CONVERSION SYSTEM SPECIFICATIONS

4.0 AERODYNAMICS AND PERFORMANCE

The NACA-0018 airfoil with a 5.5% full span tab was selected for the blade. The chord is 27 in. (28.5 in. with the tab). The estimated aerodynamics are given in Figure 3 for the low α_e region, and shown in Figure 4 over 180 deg α_e . These characteristics were used in performance estimates.

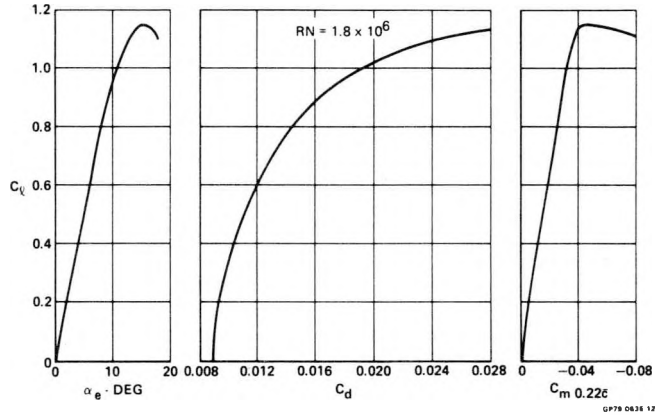

FIGURE 3 BLADE AERODYNAMIC CHARACTERISTICS NACA 0013 With Trailing Edge Modification

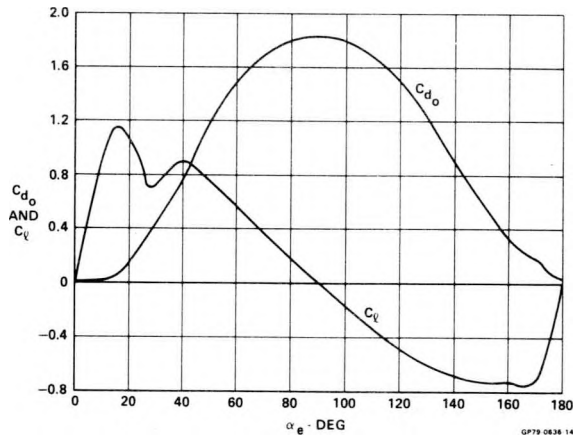

FIGURE 4 GIROMILL BLADE AERODYNAMIC CHARACTERISTICS

Performance calculations were made employing the Larsen Cyclogiro Performance Computer Program. This program accounts for rotor drag but not for blade aerodynamic damping. Figure 5 shows the estimated performance including the aerodynamic damping loss. Also shown are lines of constant rotor power (10 kW to 50 kW), and the performance point for the rock angle cam in discrete winds from 12 to 40 MPH (circled points). The double dashed lines emanating downward from these discrete wind points show how the power coefficient varies when a constant blade rock angle profile is maintained. To achieve an output of about 40 kW from an electrical generator requires the rotor to have an output of about 50 kW. The 50 kW line therefore shows the rock angle variation needed for constant power above a wind speed of 20 MPH.

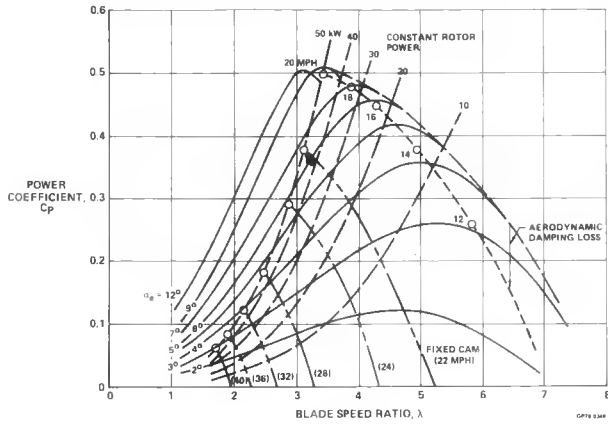

FIGURE 5 GIROMILL CONTROL PERFORMANCE

A power output breakdown is shown in Figure 6 for a wind of 20 MPH. The blade power of the prototype Giromill (no support arm drag) could provide 53 kW. Adding blade support arms reduces the power to 50.6 kW, and subtracting the power lost due to aerodynamic damping cuts that down to 49.3 kW. The control system is estimated to take about 200 watts per actuator, on the average. Therefore, 0.6 kW is allocated for control purposes. The mechanical efficiency is estimated at 94%, and the generator efficiency 91%, giving the net mechanical and electrical power values shown.

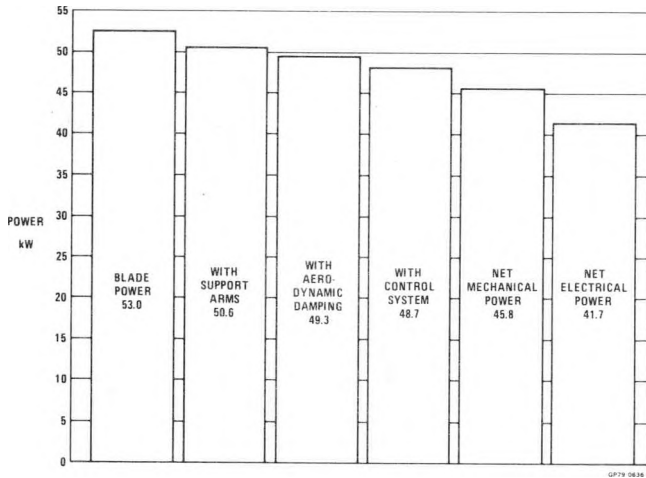

FIGURE 6 POWER OUTPUT BREAKDOWN
20 MPH Wind

The resulting annual energy expected from the Giromill as a function of the mean wind speed site is shown in Figures 7 and 8 for two rotor centerline heights. The first is for a prototype Giromill height of 75 ft; the second is for a height of 50 ft, which is planned for production units. These annual energy charts can be used for calculating energy costs.

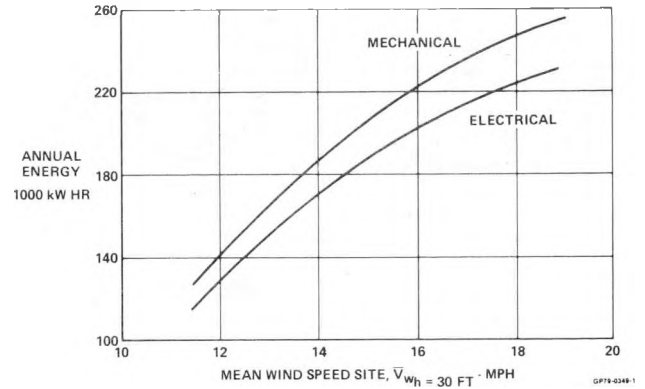

FIGURE 7 ANNUAL ENERGY

Rotor Centerline at h = 75 ft
High Wind Cutoff 40 MPH
Low Wind Cutoff 10 MPH

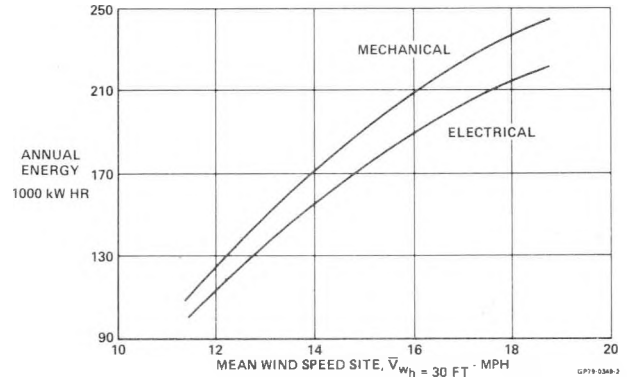

FIGURE 8 ANNUAL ENERGY

Rotor Centerline at h = 50 ft
High Wind Cutoff 40 MPH
Low Wind Cutoff 10 MPH

5.0 EXTERNAL LOADS

The external loads applied to the Giromill are aerodynamic and inertia loads. The inertia loads are composed of centrifugal (acting radial), weight loadings and snow and ice loadings. The critical design load conditions are summarized in Figure 9.

	CONDITION	DESCRIPTION	BLADES	SUPPORT ARMS	ROTATING TOWER	FIXED TOWER
ULTIMATE LOADS	1A	MAXIMUM OUTBOARD BLADE RADIAL LOAD	✓		✓	✓
	1B	MAXIMUM INBOARD BLADE RADIAL LOAD		✓	✓	✓
	2	MAXIMUM BLADE TANGENTIAL AND COMBINED RADIAL AND TANGENTIAL LOAD		✓	✓	
	3A	STORM LOADS WITH ICE		✓		✓
	3B	STORM LOADS WITHOUT ICE				✓
	4	OPERATING LOADS FOR FATIGUE DESIGN	✓	✓	✓	✓

GP19-0373-21

FIGURE 9 SUMMARY OF CRITICAL DESIGN LOAD CONDITIONS

The maximum ultimate radial loads (Conditions 1A and 1B) are shown in Figure 10. The air loads shown are developed by a dynamic stall condition where a gust hits the blade at 270 deg from the wind. At this position the velocity vectors for the wind, rotation and gust add directly to give the highest possible velocity.

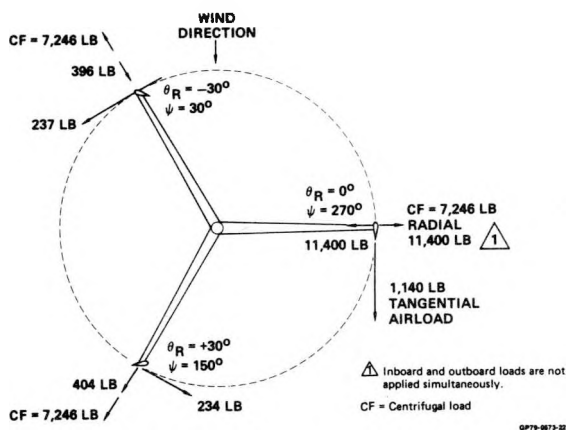

FIGURE 10 GIROMILL ULTIMATE DESIGN LOAD Condition 1

The greatest operating air loads on the blades occur in a 20 MPH wind. For fatigue design the normal airloads in a 20 MPH wind, plus a longitudinal gust factor of 1.3, were superimposed (Condition 4). These loads are shown in Figure 11. In addition to these operating loads some of the high gust loads previously discussed were included in the fatigue spectrum.

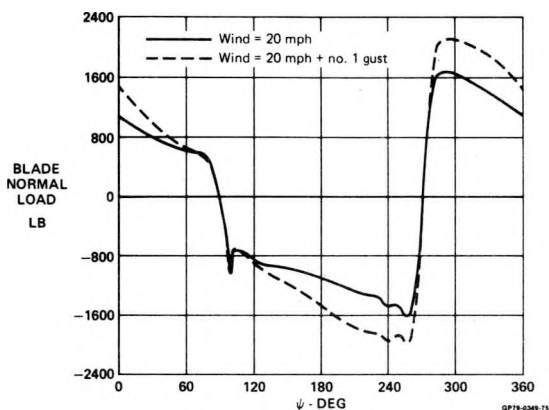

FIGURE 11 BLADE AERODYNAMIC NORMAL LOAD
6.0 ROTOR DESIGN

The rotor consists of a central steel tube rotating tower with three aluminum blades supported by six steel support arms (two for each blade). The support arms are pinned at the rotating tower and supported by streamlined steel rods that run from the tip of the support arms to the rotating tower. A bearing at the top of the fixed tower and a bearing at the lower end of the fixed tower support the rotating tower. The rotating tower extends to the ground to reduce the bearing loads and to locate the transmission and generator for easy maintenance.

Each Giromill blade is a two-cell sheet metal airfoil consisting of a 0.16 in. leading edge skin, a 0.125 in. channel spar, and a 0.020 in. beaded trailing edge skin. A cross-section of the blade is shown in Figure 12. Blade bending, shear, and torsion are carried by the leading edge and spar. The beaded trailing edge structure acts as a truss member to transfer local air loads to the leading edge torque box.

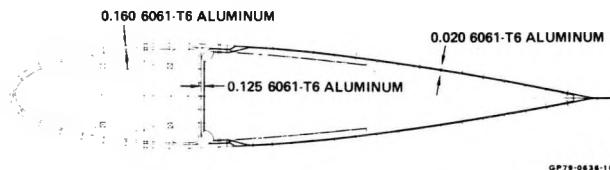

FIGURE 12 BLADE CROSS-SECTION

The blade, is attached to the rotor arm through a 4140 steel tube fitting inserted into the end of each blade section (Figure 13). Blade bending is transferred to the tube by a coupling between two machined aluminum ribs. Torsion in the blade is transferred through bolts attaching the root rib to a flange on the support tube fitting.

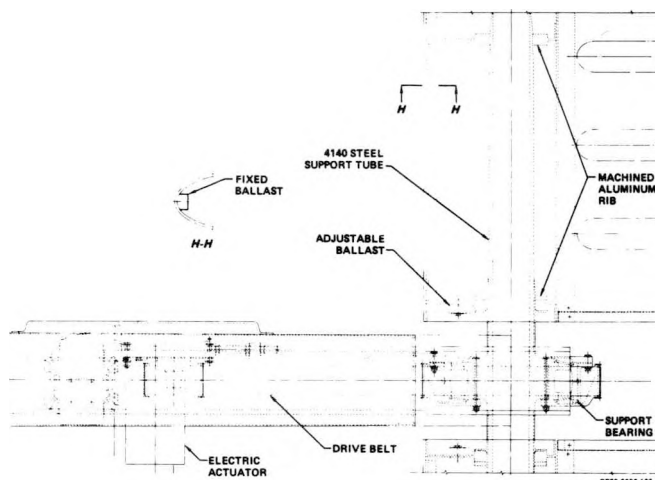

FIGURE 13 BLADE GENERAL ARRANGEMENT

Fixed ballast is placed in the leading edge of the blades to place the c.g. at 23.25% of chord. An adjustable ballast is attached to the root rib for fine tuning the c.g. during testing.

The support arms are a welded steel box cross section. The arms are tapered and streamlined to minimize aerodynamic drag losses. The outboard half of the arms is smaller and more streamlined. The outline of the support arms is shown in Figure 14. Attachment of the support arms to the rotating tower is shown in Figure 15. The braces for the support arms are a streamlined shape formed from 0.625 in. diameter stainless steel bar. Turnbuckles are used for rigging adjustments.

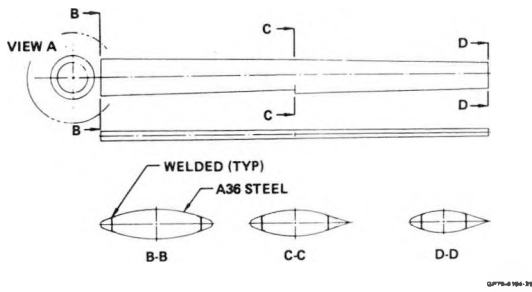

FIGURE 14 GENERAL ARRANGEMENT SUPPORT ARM

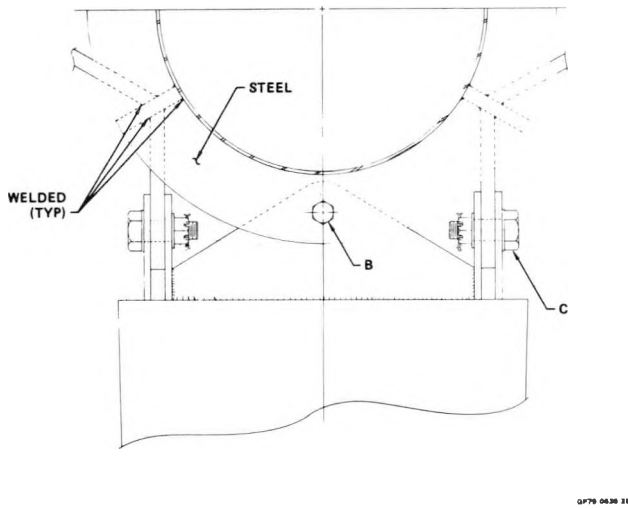

FIGURE 15 ARM/TOWER ATTACHMENT

The rotating tower is made of flanged tubular sections which are bolted together. The middle sections are A36 steel tubing, 24 in. dia. by 0.187 in. wall thickness. Figure 16 illustrates the rotating tower.

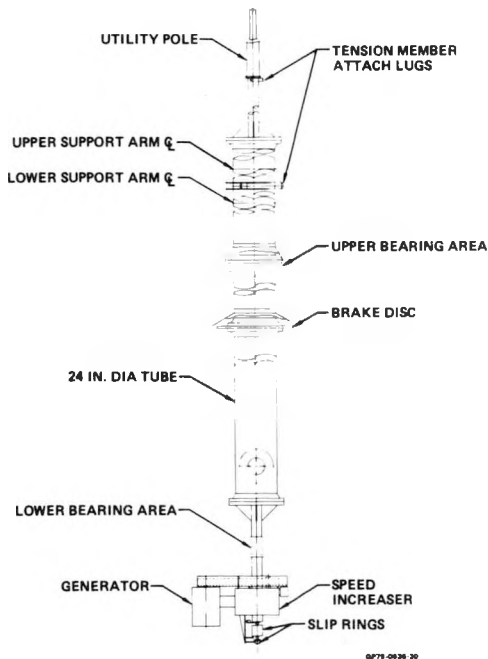

FIGURE 16 ROTATING TOWER

A tubular tapered steel utility pole 30 ft tall is mounted on top of the rotating tower to provide a 45 deg cone of lightning protection.

7.0 FIXED TOWER

The fixed tower is a truss type made of ASTM A36 structural steel angles. The joints are bolted. Figure 17 shows the fixed tower.

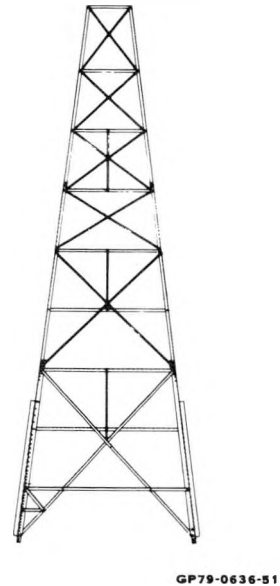

FIGURE 17 FIXED TOWER

The upper bearing for the rotor is a sealed ball bearing. The inner bearing race is bolted to a flange on the rotating tower, as shown in Figure 18. The outer race is bolted to a steel ring for reinforcement. To provide a flexible mounting, the bearing assembly is attached to the fixed tower with four thin sheets of steel.

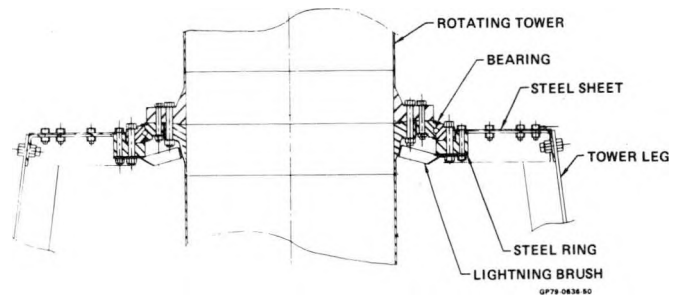

FIGURE 18 UPPER BEARING MOUNTING Side View

A tapered roller bearing is used for the lower bearing. This bearing can be relubricated. It is bolted to a plate that is suspended from the four tower legs by four tension members. Turnbuckles are used to adjust the length of the four tension for proper vertical location of the lower bearing. Four horizontal members take the side load on the bearing.

A disc brake system is designed into the prototype for emergency situations. The brake disc is bolted between two flanges of the rotating tower. The caliper is actuated by internal springs and released by hydraulic pressure. In all normal operating and standby modes the caliper is in the released position.

For lightning protection, four 1 in. square brushes provide a parallel path around the upper bearing. Four 1 in. brushes also run on the brake disc to provide a parallel path around the lower bearing. A 1 in. diameter grounding rod is attached to each leg of the fixed tower.

The fixed tower has a spread foundation made up of four concrete piers. Figure 19 illustrates a typical pier. Two 1.5 anchor rods extend out of each pier.

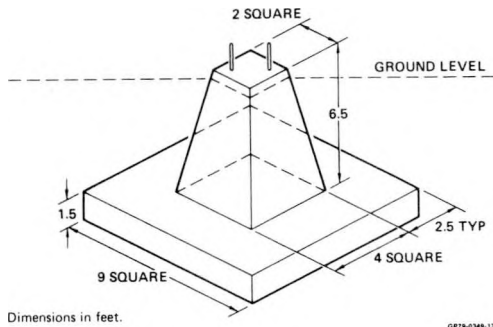

FIGURE 19 FOUNDATION PIER

8.0 WEIGHTS

The prototype has a weight of 32,983 lb. Production units with shorter towers are estimated to weight 26,148 lb. Figure 20 summarizes the weight by major component.

	PRODUCTION UNIT WEIGHT (LB)	PROTOTYPE WEIGHT (LB)
ROTOR		
BLADES	1,308	1,308
BLADE FAIRINGS	90	90
SUPPORT ARMS	4,430	4,430
ROTATING TOWER	8,350	11,000
FIXED TOWER		
STRUCTURAL	9,280	13,465
UPPER BEARING	190	190
LOWER BEARING	560	560
CONTROL SYSTEM	400	400
ELECTRICAL OUTPUT SYSTEM		
GEARBOX	850	850
GENERATOR	480	480
BELT STAGE AND ELECTRICAL EQUIPMENT	210	210
	26,148	32,983

FIGURE 20 GIROMILL WEIGHT BREAKDOWN

9.0 STRUCTURAL DYNAMICS

Structural dynamics studies were directed towards insuring that design adequacy existed in the areas of vibration, flutter, and structural response. Figure 21 is a frequency diagram comparing the vibration modes of interest and their possible excitation due to rotational forcing functions. Note that the advancing and retreating branches of rotating tower bending intersect the 1P and 3P excitation lines above the operating frequency. The same behavior is shown for the support-arm lag-lead bending mode. This suggests smooth start-up and shut-down with minimal vibration.

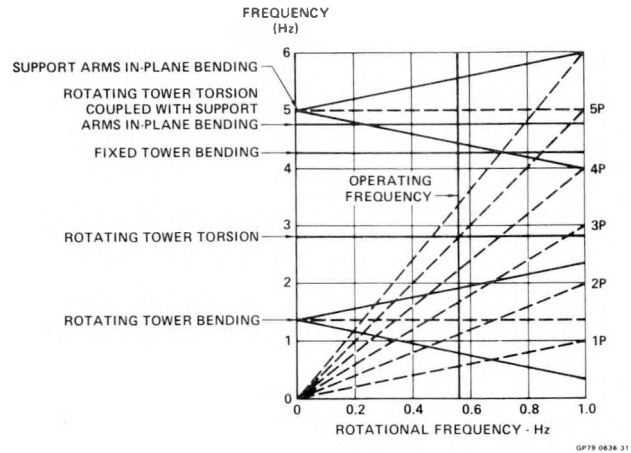

FIGURE 21 STRUCTURAL FREQUENCIES VS ROTATION Fixed Coordinate System

Blade flutter speed was checked and found to be well above $1.2 V_{max}$ at the blade pitch frequency of 9.5 hz. The blade hinge moment stiffness requirements from the blade actuation system through the back up structure was designed to give that blade pitch frequency.

10.0 CONTROL SYSTEM DESIGN

The final control concept that evolved was a proportional plus integral feedback on rotor RPM, summed with a measured blade speed command used for RPM control in the gusty wind conditions expected. The rock angle commands generated by a control unit are transmitted to individual electrical blade actuators. Each actuator consists of an electrical motor, power amplifier, and gear box. The actuators position the blades according to the commands.

Two major analysis efforts were undertaken to evolve this system. One studied the closed loop response of the entire Giromill system (controller, actuators, rotor, and generator). The other defined the actuator response characteristics.

An early evaluation of the control response characteristics was obtained from a simplified steady state analysis of the blade and actuator, the rotor system, control unit, and generator. A simplified representation of the system studied is shown in Figure 22.

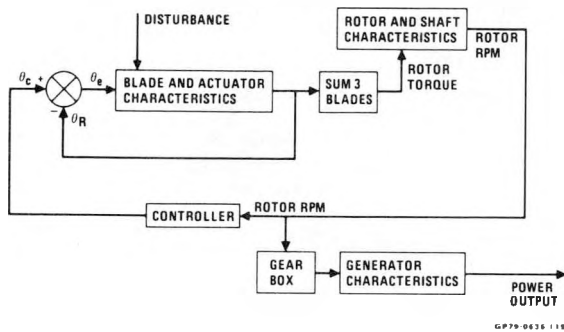

FIGURE 22 STEADY STATE LINEARIZED CONTROL SYSTEM REPRESENTATION

Induction Generator with Grid Tie-In

This system representation was used to gain an insight of the system characteristics, support the various trade studies that were in progress, and establish boundaries of various parameters to be looked at using the more complex Continuous System Modeling Program (CSMP) simulation (See later discussion). It gave an overall view of the entire system, and being linear, was adaptable to standard analysis techniques.

Figure 23 shows the time response of this simple representation to an arbitrary saw tooth forcing function. The amplitude of the forcing function was such that it could cause power surges over twice the nominal operating power. Three frequencies were simulated: 1/8, 1/4, and 1/2 cycles per second.

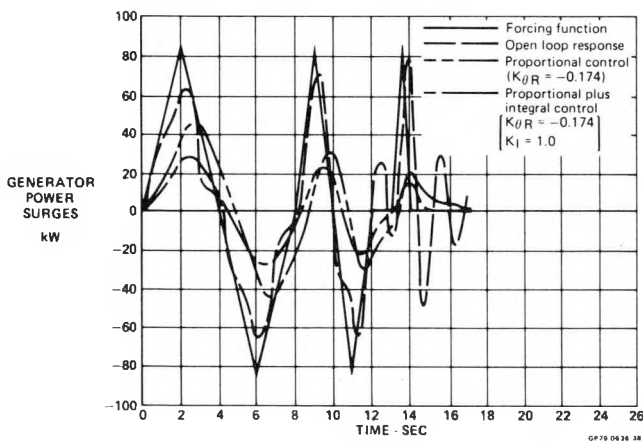

FIGURE 23 STEADY STATE LINEARIZED CONTROL TIME RESPONSES

Three responses are plotted: (1) the open loop response, (2) proportional control only, and (3) proportional plus integral control. The open loop response shows that power surges almost equal to the forcing function amplitude can occur. It also shows that the rotating tower torsional frequency, estimated at that time at 0.6 Hz, was excited and caused several cycles of ringing. Closing the loop through a proportional controller reduced the power surges considerably and prevented the ringing in the tower. Adding an integral feedback loop further reduced the power surges to a manageable value.

The CSMP program was employed to get an accurate simulation of the entire operating Giromill system and establish confidence that the control scheme would work. This program can simulate the nonlinear characteristics of a dynamic system. All important dynamic characteristics of the Giromill were modeled including: (a) Actuator, (b) Blade moment components, (c) Induced flow and rotor torque, (d) Rotor dynamics, (e) Generator, and (f) Controller. Various parameters, time constants, and control gains were evaluated to establish the values for the actual prototype.

Also investigated were the maximum blade loads expected with severe wind gusts. A wind gust which went from 30 to 44.5 MPH in 0.5 sec was employed. The results are shown in Figure 24.

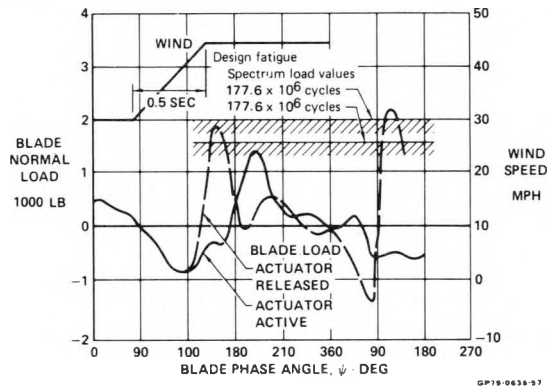

FIGURE 24 BLADE LOADS DUE TO SEVERE GUST

The solid line shows the blade loads with the blade actuator active through the gust. The maximum load does not reach the lowest fatigue spectrum load value. However, a gust of this magnitude causes a generator power surge to 75 kW. Assuming that this is higher than desired the controller commands the blades to be released and go into a weathervane mode. The dashed line shows the blade loads due to releasing the actuator. There is a significant overshoot in blade angle of attack. However, the airloads are only slightly greater than the second fatigue spectrum load value for this severe gust. With the blades weathervaning the rotor RPM decreases rapidly, being less than 30 at the end of the plotted values.

Many of the analyses used the wind gust profiles shown in Figure 25 and 26 for evaluating the system. A below-rated-power wind gust does not exceed the maximum cut-off wind speed, for our case 40 MPH (58.7 ft/sec). The above-rated-power wind gust exceeds this value.

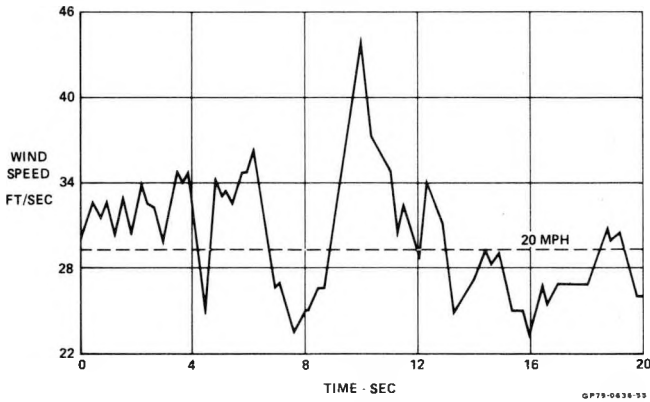

FIGURE 25 BELOW-RATED-POWER WIND GUST

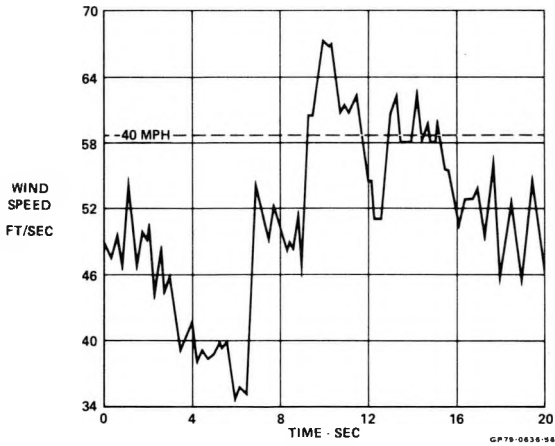

FIGURE 26 ABOVE-RATED-POWER WIND GUST

Figures 27 and 28 give some typical results using these profiles, showing the commanded rock angle for blade one and the rock angle error (difference between commanded and actual). The error is small for the low wind speed gust, but increases at higher winds. This is because the rock angle increases as the wind increases, and the actuator has more difficulty in following the profile. Figure 29 compares several other parameters of these two cases.

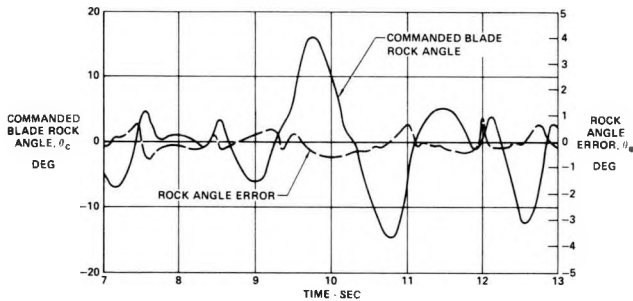

FIGURE 27 BLADE 1 ROCK ANGLE AND ROCK ANGLE ERROR
Below-Rated-Power Wind Gust

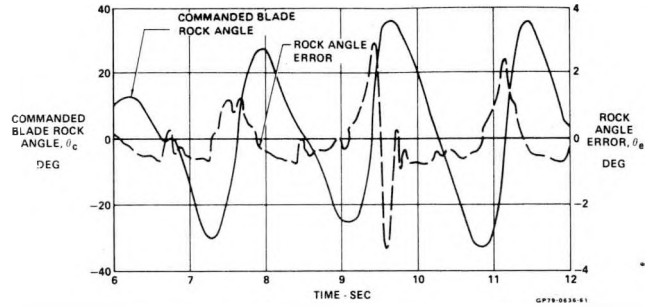

FIGURE 28 BLADE 1 ROCK ANGLE AND ROCK ANGLE ERROR
Above-Rated-Power Wind Gust

		ABOVE RATED WIND GUST	BELOW RATED WIND GUST
MAX BLADE LOAD	(LB)	1333	1718
MAX kW OUTPUT		79	67
MAX BLADE ROCK ANGLE ERROR	(DEG)	3.3	1.0
AVERAGE ACTUATOR MOTOR POWER OVER 18 SEC	(WATTS)	90	74
MAX ROTOR ACCELERATION	(RAD/SEC ²)	0.356	0.139
MAX BLADE ANGLE-OF-ATTACK	(DEG)	11.8	14.3

FIGURE 29 WIND GUST RUNS COMPARISON

Analyses to size the actuator were also completed. Figure 30 shows the actuator torque, rate and acceleration requirements for a 40 MPH wind. Figure 31 shows how the actuator rate and acceleration vary with wind speed. This exponential increase was the primary reason for lowering the original design wind speed of 60 MPH down to 40 MPH.

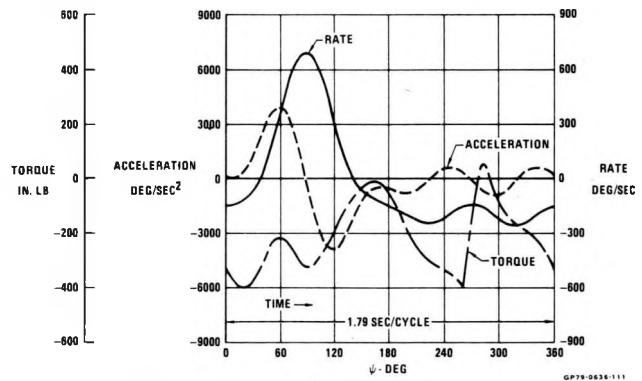

FIGURE 30 BLADE ACTUATOR REQUIREMENTS
40 MPH

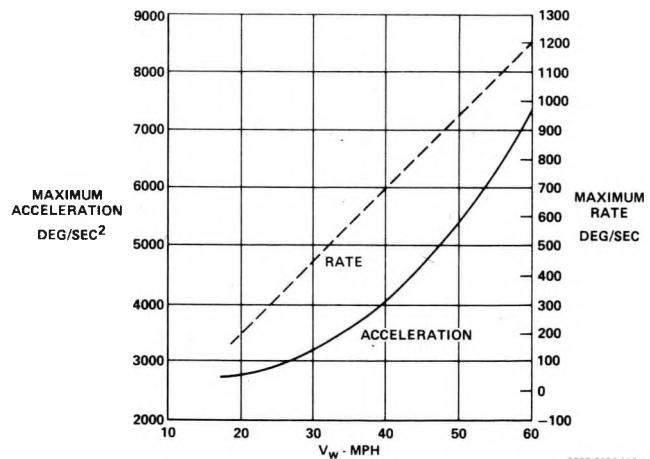

FIGURE 31 BLADE ACTUATOR MAXIMUM RATE
AND ACCELERATION

A non-linear simulation model of the actuator was developed to determine its characteristics and stability. This model was also used to check the simplified model used in the CSMP computer analysis, previously discussed. Figure 32 shows that they compared very well.

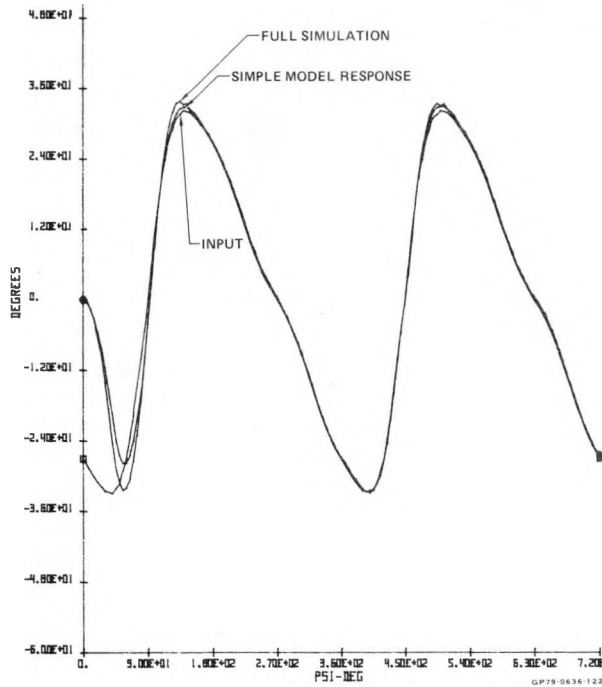

FIGURE 32 ACTUATOR MODEL COMPARISON
40 MPH

The control system is housed in two enclosures: (1) control unit and (2) power switching unit. These enclosures are mounted on the control panel at the base of the fixed tower.

The control unit utilizes a microprocessor in conjunction with three programmable read-only memories (PROMS) and associated interface circuits. The rock angle profiles, Figure 33, are stored in the PROMS and used for commanding the blade actuator as a function of the blade phase angle, Ψ , and rotor RPM. Self tests in the controller assure a fail safe system.

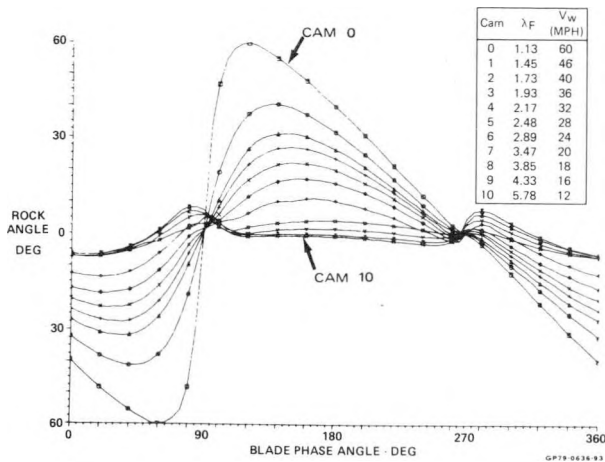

FIGURE 33 PROGRAMMED ROCK ANGLE PROFILES

Figure 34 summarizes the phase sequence of the processor for controlling the Giromill. Phase 0 is turn on. Turn on is accomplished through the wind stand-by circuit indicating the winds are in operating range, or $10 \leq V_w \leq 40$ MPH and V_w has been above 13 and below 37 MPH for one minute at start up. Phase 1 is a diagnostic self-check of the processor functions. Phase 2 and 2A starts the start up time limit clock (120 sec.) and assures correct rotation of the rotor. The clock measures the time to get to 32.92 RPM. If that RPM is not reached in 120 sec. during Phase 3, the processor will switch to Phase 6. If the RPM is above 15, the blade actuators will be released allowing the rotor to coast down to 15 RPM where the actuators are again activated and the processor returned to Phase 3. If this loop occurs 5 times the system will be shut down. Phase 4 is the normal power operating phase. In event of a rotor overspeed, Phase 5 will release the blade actuators but keep the generator connected until the rotor has slowed down to generator synchronous speed (32.92 RPM). The processor will then switch to Phase 6 which will again start up the rotor when 15 RPM is reached.

PHASE	RPM RANGE	ACTUATOR POWER	GRID CONNECT	NEXT PHASE	CONDITIONS FOR GOING TO NEXT PHASE	TIME LIMIT	SHUTDOWN CONDITIONS
0	-	OFF	NO	1	PROCESSOR POWER TURN ON	-	-
1	-	OFF	NO	2	INITIALIZE COMPLETE AND SELF TEST GO	-	SELF TEST FAILURE
2	$\omega < 7$ RPM	ON	NO	2A	ROTOR HAS FORWARD ROTATION	120 SEC	TIME LIMIT
2A	$\omega < 7$ RPM	ON	NO	3	FIRST RPM SENSOR FLAG		TIME LIMIT
3	$\omega < 32.92$ RPM	ON	NO	6	TIME LIMIT		RPM FROM RPM SENSOR \neq RPM FROM ROTOR ANGLE POT
				4	$\omega > 32.92$ RPM		
4	$32.92 \leq \omega \leq 33.83$	ON	YES	3	$\omega < 32.92$ RPM	NO LIMIT	RPM SENSOR FLAG PERIOD > 64 MILLISECONDS
				5	$\omega > 33.83$ RPM		
5	$33.83 \geq \omega \geq 32.92$	OFF	YES	6	$\omega < 32.92$ RPM	60 SEC	TIME LIMIT
6	$32.92 > \omega > 15$ RPM	OFF	NO	3	$\omega < 15$ RPM		TIME LIMIT OR PHASE 6 - PHASE 3 LOOP COUNT > 5

FIGURE 34 GIROMILL CONTROL SYSTEM-PROCESSOR
PHASE SEQUENCE

The Giromill rock angle actuator is a self contained servo mechanism which controls the angular position of the output shaft in response to a position signal. This servo mechanism consists of an electronic control amplifier and a direct drive actuator powered by a dc motor operating from the 48 volt supply. An isometric view of the actuator is shown in Figure 35.

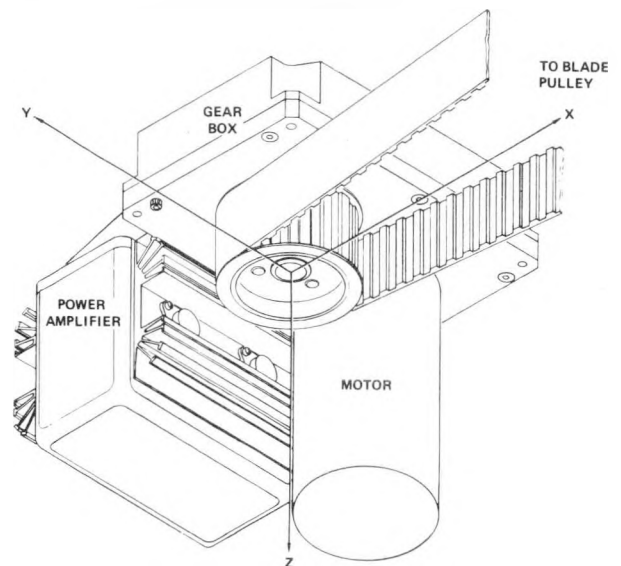

FIGURE 35 BLADE ACTUATOR ASSEMBLY

The power amplifier consists of a servo amplifier board and a servo driver board, which are connected together by an interconnect board. The output power transistors are mounted on two heat sinks. The electronics, exclusive of the heat sinks and transistors, are enclosed.

The rock angle actuator gearbox is a two stage, spur gear reduction gearbox. Under normal operating conditions, the lubricant in the gearbox is centrifuged to the outermost side (+ x direction in Figure 35), where the gearing will be constantly lubricated by running partially submerged in oil.

Power for the control system is generated by a 48 volt alternator, driven by a toothed belt from the main gear box at the bottom of the rotating tower.

11.0 MECHANICAL AND ELECTRICAL OUTPUT POWER SYSTEM

A shaft mounted helical gear box speed increaser, having a gear ratio of 24.3 to 1, is mounted on the lower end of the rotating tower. The output shaft of gear box drives the generator through a toothed belt final stage for an overall increase of 54.675 to 1. For the electrical output Design 1 the generator speed is 1830 RPM. Figure 36 shows the electrical drive system assembly.

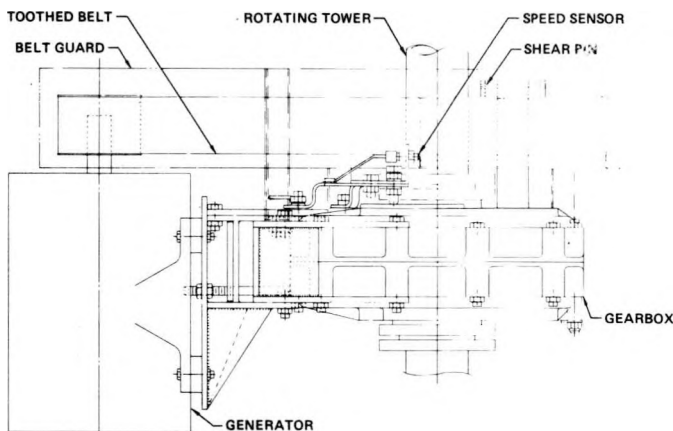

FIGURE 36 ELECTRICAL DRIVE SYSTEM ASSEMBLY Side View

An induction generator is used to feed 480 volt, 3 phase, 60 Hz power into a large utility grid. A magnetic starter, controlled from the control system, to connect the Giromill to the utility grid. Figure 37 is a block diagram of Electrical Design 1.

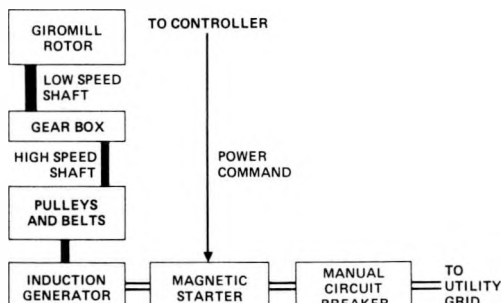

FIGURE 37 BLOCK DIAGRAM OF GIROMILL ELECTRICAL OUTPUT POWER FOR OPERATION WITH A LARGE UTILITY GRID

Electrical Output Designs 2 and 3 are stand-alone systems. A synchronous generator with voltage regulator and exciter is used for electrical power.

Electrical Output Design 4 is a 480 volt, 3 phase, 60 Hz Giromill suitable for tie-in with one or more other small generators to form a small utility grid. A synchronous generator with voltage regulator and exciter is used. A load sensor provides information to the Giromill controller so the machine will pick up the load and synchronize it properly.

The Mechanical Output Kit converts the Giromill from an electrical output to a 1760 RPM mechanical output through a horizontal shaft. A right angle gear box and mounting bracket replaces the electrical generator.

12.0 FAILURE MODE AND EFFECTS ANALYSIS

An analysis was conducted to determine the possible modes of failure and their effects on system reliability and safety.

Two failures were considered to be somewhat critical. One was if the wind speed sensor operates slower than the actual wind speed. This could cause the Giromill to operate in a wind velocity greater than 40 MPH causing overloading of the blade actuators. Probable result is Giromill shutdown due to inability of the actuators to follow commanded values.

The other item is where the line magnetic contactor fails closed and, for some reason, shutdown is commanded by the controller. If the RPM is below rated speed, the generator drives the Giromill. Under these conditions, if the brake is applied, the generator circuit breakers will open the line connected to the grid, causing shutdown.

All other failures are non-critical.

13.0 TEST INSTRUMENTATION

Desired quantities to be measured by installed instrumentation during the test phase include structural loads, structural vibration frequencies and mode shapes, control system performance parameters, and overall Giromill performance. Provisions have been made for extracting all the data. However, at this time only the bare minimum of instrumentation would be hooked up due to limited ground test equipment availability. This partial instrumentation approach is shown in Figure 38.

- BLADE
 - INSTALL STRAIN GAUGES AND ACCELEROMETERS. 3 ACCELEROMETERS, 1 STRAIN GAUGE AND 2 ROSETTES
 - RUN WIRES TO JUNCTION TERMINAL
 - MAKE MOUNTING PROVISIONS FOR SIGNAL CONDITIONER AND MULTIPLEXER
 - INSTALL SLIP RINGS BETWEEN BLADE AND SUPPORT ARM
- SUPPORT ARM
 - INSTALL TEMPERATURE PROBES IN ACTUATORS 3 THERMOCOUPLES
 - USE TEMPERATURE SENSITIVE INDICATORS ON ACTUATOR MOTORS
- FIXED TOWER
 - INSTALL STRAIN GAUGES AND ACCELEROMETERS. 2 ACCELEROMETERS AND 5 STRAIN GAUGES
 - HOOK UP AND USE AS NEEDED
- CONTROL PARAMETERS AVAILABLE

GP 78-0072 11

FIGURE 38 PARTIAL INSTRUMENTATION APPROACH

One blade will have the instruments installed during assembly, with the wires routed to a terminal connector and tied off. Three thermocouples will be mounted in an actuator and the wires taped and tied down. To gain a qualitative insight of actuator temperatures, several temperature sensitive indicators will be put on an actuator.

The strain gauges and accelerometers on the fixed tower will be installed after assembly of the Giromill. These instruments can be hooked up and data taken depending on the number of recorders available. Control system parameters, such as rock angles, rotor position, and wind velocity, are available from the instrumentation plug on the controller box. Again, depending on the ground equipment available, these can be hooked up and data taken.

14.0 TEST PLAN

Preliminary testing will be performed with the electrical system configuration at Valley Industries Plant at Tallulah, La. Tests will include pre-start inspections, functional instrumentation checks, and limited functional testing.

These tests will be repeated at Rocky Flats along with the long term and intensive data collection phases. Long term data collection will include the continuous measurement of machine performance and measurement of the input wind characteristics. Intensive data collection is characterized by short periods of data collection during continuous Giromill operation, as well as during specific operational conditions critical to structural and dynamic performance characteristics.

The overall plan is to proceed through the following test phases at Rocky Flats with the electrical system configuration.

- Pre-start up checkout
- First start up checks
- Dynamic tests
- Performance tests
- Special tests

Upon satisfactory completion of electrical system tests, the unit will be converted to the mechanical system for final operational testing.

15.0 PRELIMINARY BUDGETARY PRODUCTION COSTS

A preliminary budgeting estimate was made of the production cost for the 1000th unit. The basic ground rules are listed in Figure 39. The results are shown in Figure 40.

16.0 CONCLUSIONS AND RECOMMENDATIONS

The Design Phase determined that the Giromill was feasible and a strong candidate to meet energy needs at a competitive cost. Further advancements with high payoff are possible with efforts in the following areas.

A weight reduction program, coupled with a cost reduction program, should be undertaken for production units.

Rock angles could be simplified to increase the Giromill capability.

A mechanical controller could increase reliability and reduce cost.

The present system should be updated and larger systems investigated.

A two bladed rotor would cost less and is feasible. Analyses should be undertaken to overcome the associated problems.

- 1977 DOLLARS WILL BE USED
- THE COST WILL INCLUDE G AND A AND PROFIT
- SELLING EXPENSE AND TRANSPORTATION WILL NOT BE INCLUDED
- FOUNDATION AND ERECTION COSTS WILL NOT BE INCLUDED
- VALLEY INDUSTRIES WILL BUILD THE ENTIRE UNIT
- RDT&E AND TOOLING COSTS WILL NOT BE INCLUDED
- ROTOR CENTERLINE WILL BE PLACED TO PROVIDE A 30 FT GROUND CLEARANCE
- CUT OUT SPEED SHALL BE AT A WIND SPEED OF 40 MPH
- ALL OTHER REQUIREMENTS SHALL BE AS SPECIFIED IN TABLE I OF THE SOW
- AN APPROPRIATE LEARNING CURVE WILL BE DETERMINED AND APPLIED FOR EACH COMPONENT PART OF THE GIROMILL

GPT-0388-124

FIGURE 39 GROUND RULES FOR COSTING 1000TH UNIT

	1st UNIT	1000th UNIT		
		△	△	△
FIXED TOWER	\$ 5,961	\$ 3,636		
ROTATING TOWER	11,686	4,006		
SUPPORT ARMS	6,862	2,076		
STREAMLINE RODS	1,556	724		467
BLADES	13,693	4,944		
UPPER BEARING	878	583	488	263
LOWER BEARING	1,624	1,446	902	487
CONTROL SYSTEM	7,039	4,084		
SPEED INCREASER	3,810	3,026	2,118	1,143
MAIN DRIVE PULLEY	559	167		
MAIN GENERATOR PULLEY	194	58		
MAIN DRIVE BELT	89	67	49	27
INDUCTION GENERATOR	1,060	622	589	318
ELECTRIC COMPONENTS	369	301	205	111
TOTAL MATERIAL, LABOR, OVERHEAD	\$55,380	\$25,740	\$24,046	\$21,787
G&A (7%)	3,877	1,802	1,683	1,525
PROFIT (10%)	5,926	2,754	2,573	2,331
TOTAL	\$65,183	\$30,296	\$28,302	\$25,643
DOLLARS/KILOWATT (41.7 kW)	\$ 1,563	\$ 727	\$ 679	\$ 615

- △ Based on vendor quotations
- △ Based on 95% learning curve on vendor items
- △ Based on 90% learning curve on vendor items

GPT-0015-02

FIGURE 40 GIROMILL BUDGETARY COST ESTIMATE

17.0 REFERENCES

1. Brulle, R.V., "Feasibility Investigation of the Giromill for Generation of Electrical Power", Vol I - Executive Summary, Vol II - Technical Discussion, ERDA Report C00-2617-76/1, April 1976.
2. Moran, W.A., "Giromill Wind Tunnel Test and Analysis", Vol I - Executive Summary, Vol II - Technical Discussion, ERDA Report C00/2617-4, October 1977.